



Conical Rounders

02

Capacity up to 4000 pieces/hour and weight range between 30-1800 grams.

FOR WHO?

Bakeries.

Semi-Industrial Bakeries.

Industrial Bakeries.

WHY CR400?



Flexible dough weight



Movable



Easy to clean



MEASUREMENTS AND DRAWINGS [MM]

With outfeed chute

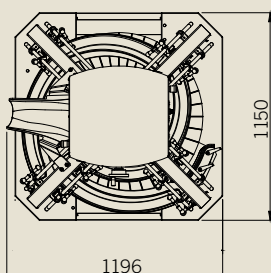
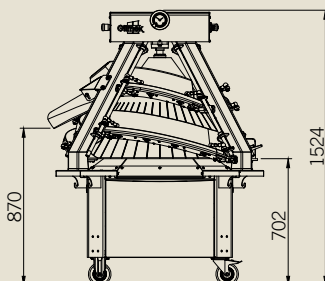

With outfeed conveyor

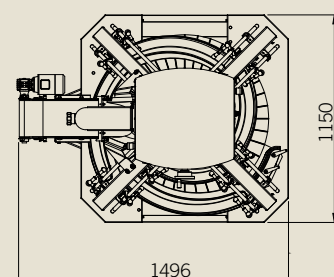
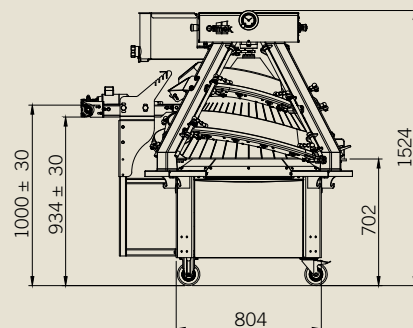

Conical Rounder

CR400

A very flexible cone rounder for all kind of bakeries, suitable for most types of dough. Centrally adjustable non-stick coated tracks processes the dough for ultimate rounding. Made in stainless steel for highest hygenic execution.

FEATURES AND BENEFITS

Capacity up to 4000 pcs/h subject to dough piece weight and characteristics.

Weight range 30-1800 g, subject to capacity and dough characteristics.

Wide variety of options make it possible to meet the customer demand. Flexible setup.

Hygienic materials, easy to clean due to adjustable tracks and stainless steel execution.

Rounding length, up to 4 m depending on infeed position.

Special designed infeed track catches the dough in a smooth and gently way, manually adjusted.

Centrally adjustable rounding tracks for dough pressure regulation and flexible weight range.

Blue plastic track bottom plate.

Parts in blue for better detection and food safety.

Easy to clean and maintain due to adjustable tracks.

Non-stick coating on cone and tracks for ultimate rounding.

Cone with grooves for optimized grip.

Outfeed chute with small dimples for better outfeed properties.

Weight adjustment handle at 3 or 9 o'clock.

Robust construction with strong stainless steel frame and high quality premium castors.

Stainless steel castors with bearings and blue plastic.

Operation panel easily accessible from both sides.

Cable suspension underneath facilitates cleaning.

High safety with two emergency stops.

OPTIONS

Flour Duster in stainless steel, adjustable with easy on-off function.

Hot and Cold air blowing unit (affects power supply, plus 1.3 kW, totally 2.8 kW).

Variable cone speed with frequency converter.

Infeed at 3 or 9 o'clock.

Oiling device, pneumatic, with 5 nozzles. Compressed air required 6 bar.

Extra robust outfeed conveyor with high stability and variable height instead of standard outfeed chute.

Variable speed for outfeed conveyor.

Height extension 80 mm, stainless steel.

Height extension 100 mm, stainless steel.

Adjustable support feet.

INFEED ALTERNATIVES

Discharge always at 12 o'clock.

Standard infeed at 6 o'clock.

Optional infeed at 3 or 9 o'clock.

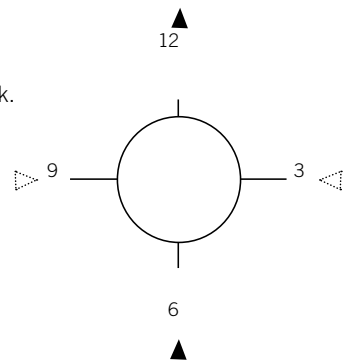

TECHNICAL

Capacity up to 4000 pieces/hour.
(subject to dough piece weight and characteristics).

Weight range 30-1800 g.
(subject to dough piece weight and characteristics).

Recommended fuse (amp) 16 A.

Power supply 1.5 kW.
(2.8 kW with hot and cold air blowing unit)

04

Capacity up to 6000 pieces/hour and weight range between 30-1800 grams.

FOR WHO?

Bakeries.
Semi-Industrial Bakeries.
Industrial Bakeries.

WHY CR600?



Flexible dough weight



Long rounding length



Movable



High capacity



MEASUREMENTS AND DRAWINGS [MM]

With outfeed chute

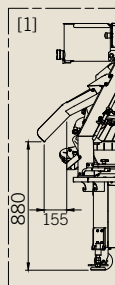
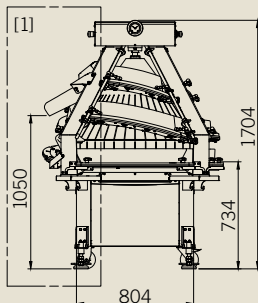

With option:
• Extension for outfeed chute.
• Flour Duster.

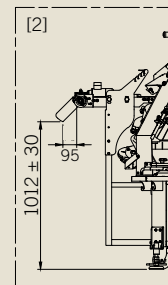
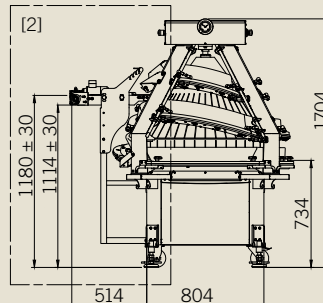

With option:
• Extension Chute (short).

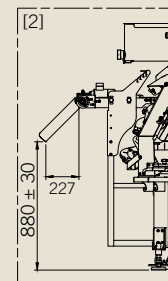
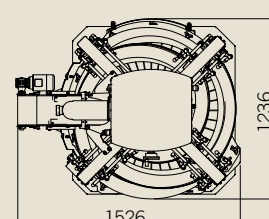
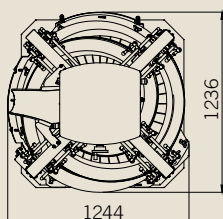

With option:
• Extension Chute (long).
• Flour Duster.

Conical Rounder

CR600

Flexible and high capacity cone rounder for all kind of bakeries, suitable for most types of dough. Two individually adjustable rounding sections processes the dough for ultimate rounding and optimized result. Made in stainless steel for hygienic execution.

FEATURES AND BENEFITS

Capacity up to 6000 pcs/h subject to dough piece weight and characteristics.

Weight range 30-1800 g, subject to capacity and dough characteristics.

Flexible regarding type of dough.

Wide variety of options make it possible to meet the customer demand. Flexible setup.

Special designed infeed track catches the dough in a smooth and gently way, manually adjusted.

Individual adjustable settings for rounding tracks and merging tracks:

- Centrally adjustable rounding tracks (conical part).
- Manually adjustable merger tracks (cylindrical part).

Blue plastic track bottom plate.

Parts in blue for better detection and food safety.

Hygienic materials, easy to clean due to adjustable tracks and stainless steel execution.

Long rounding length, up to 8 m depending on infeed position.

Non-stick coating on cone and tracks for ultimate rounding.

Cone with grooves for optimized grip.

Outfeed chute with small dimples for better outfeed properties.

Operation panel easily accessible from both sides.

Weight adjustment handle at 3 or 9 o'clock.

Robust construction with strong stainless steel frame, steady adjustable support feet and high quality premium castors.

Stainless steel castors with bearings and blue plastic.

Cable suspension underneath facilitates cleaning.

High safety with two emergency stops with easy access from both sides.

Easy to install.

Easy to move

OPTIONS

Control System Allen Bradley.

Flour Duster in stainless steel, adjustable with easy on-off function.

Hot and Cold air blowing unit.

(affects power supply, plus 2.3 kW, totally 3.8 kW).

Variable cone speed with frequency converter.

Infeed at 3 or 9 o'clock.

Oiling device, pneumatic, with up to 7 nozzles depending on infeed position. Compressed air required 6 bar.

Extra robust outfeed conveyor with high stability and variable height instead of standard outfeed chute.

Variable speed for outfeed conveyor.

Extension for outfeed chute.

Extension chute for outfeed conveyor - short.

Extension chute for outfeed conveyor - long.

Height extension 80 mm, stainless steel.

Height extension 100 mm, stainless steel.

INFEEED ALTERNATIVES

Discharge always at 12 o'clock.

Standard infeed at 6 o'clock.

Optional infeed at 3 or 9 o'clock.

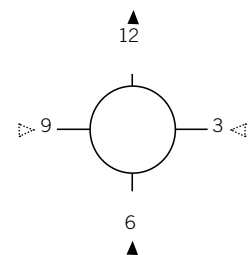

TECHNICAL

Capacity	up to 6000 pieces/hour. (subject to dough piece weight and characteristics).
Weight range	30-1800 g. (subject to dough piece weight and characteristics).
Recommended fuse (amp)	16 A.
Power supply	1.5 kW. (3.8 kW with hot and cold air blowing unit)

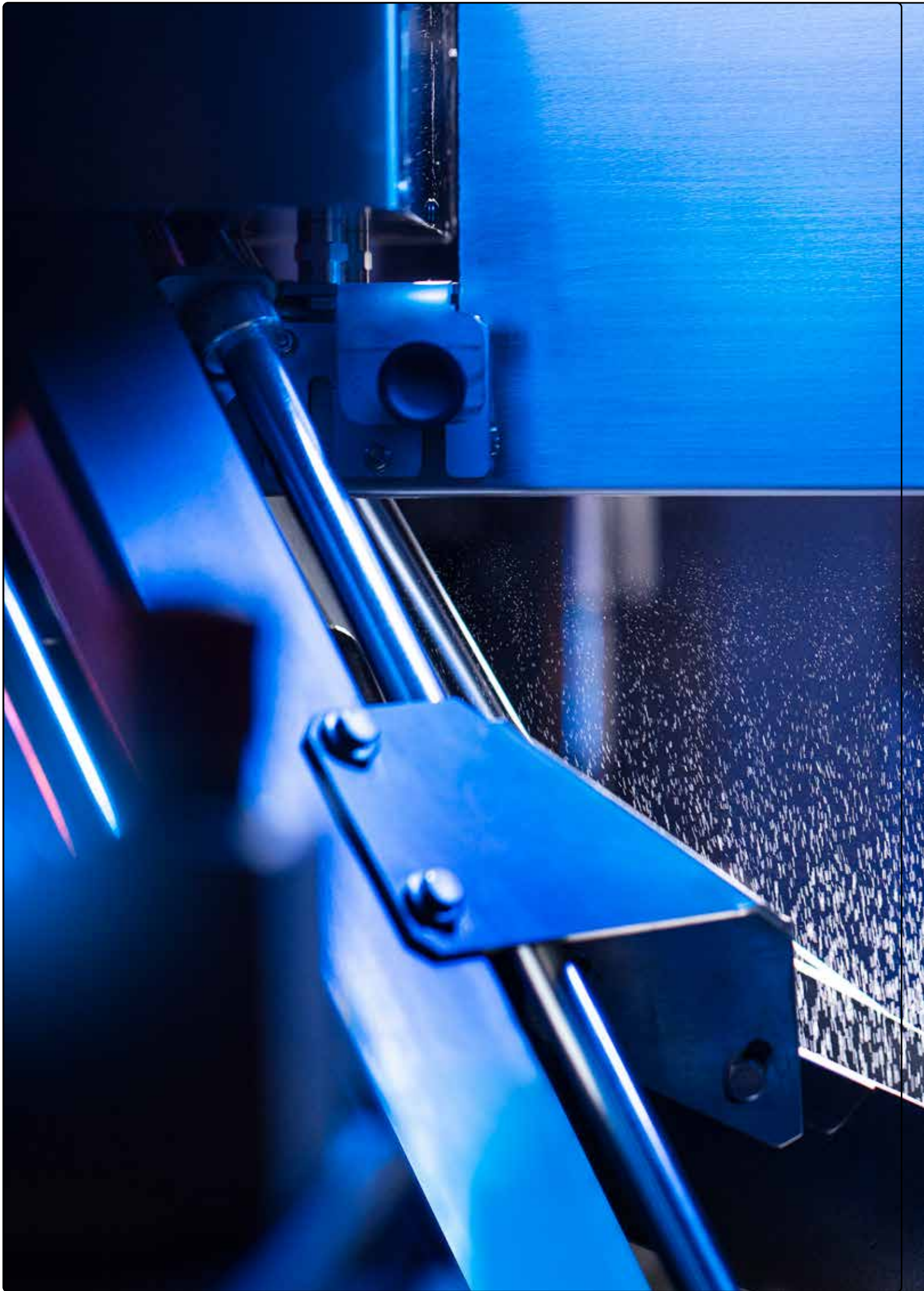



Our story

We provide customized baking solutions, dough handling equipment systems and complete bread lines for professional baking businesses.

We offer reliable technology with precision control and flexibility regarding weights and types of dough and also user-friendly design that gives baking professionals creative freedom at the lowest cost of ownership.

Sveba Dahlen AB
Industrivägen 8
513 82 Fristad, Sweden

www.glimekusa.com
www.sveba.com
info@glimek.com

